

Hubbell Power Systems, Inc. SURGE ARRESTERS

IEC 5kA, 10kA Class 1 & 2, Distribution Medium & High Surge Arresters
IEEE Normal Duty, Heavy Duty & Riser Pole Surge Arresters

Experience, Reliability & Education



Table of Contents

	Page
Warranty.....	70-3
Introduction.....	70-4
Rating Selection Considerations.....	70-5
Routine Production Tests.....	70-6
IEC Design Characteristics.....	70-7
IEC 5kA Arrester- PDV-65.....	70-10
IEC 10kA Class 1 Arrester- PDV-100.....	70-11
IEC 10kA Class 2 Arrester- PVI-LP.....	70-13
IEC 5kA Distribution Medium (DM) Arrester- PDV-65 Optima.....	70-15
IEC 10kA Distribution High (DH) Arrester- PDV-100 Optima.....	70-16
IEEE Design Characteristics.....	70-18
IEEE Normal Duty Distribution Arrester- PDV-65 Optima (ND).....	70-21
IEEE Heavy Duty Distribution Arrester- PDV-100 Optima (HD).....	70-22
IEEE Riser Pole Distribution Arrester- PVR Optima.....	70-23
Arrester Accessories.....	70-25
Ordering.....	70-26
Common Metric Hardware Options.....	70-27
Common Imperial Hardware Options.....	70-28
Protective Caps.....	70-29
Standard Mounting Brackets.....	70-30
Transformer Bracket Cover.....	70-30
Arrester Frequently Asked Questions	70-31
Engineering Terminology.....	70-33

Reliability



Warranty

Hubbell Power Systems, Inc. (Company or HPS), warrants to Buyer that the products sold will be free of defects in workmanship or material for a period of one (1) year (or as otherwise specified) from the date of original shipment by HPS when stored, installed, operated or maintained in accordance with recommendations of HPS and standard industry practice and when used under proper and normal use. HPS shall in no event be responsible or liable for modifications, alterations, misapplication or repairs made to its products by Buyer or others, or for damage caused thereto by negligence, accident or improper use by Buyer or others. This warranty does not include reimbursement for the expenses of labor, transportation, removal or reinstallation of the products. This warranty shall run only to the first Buyer of a product from HPS, from HPS' Buyer, or from an original equipment manufacturer reselling HPS' product, and is non-assignable and non-transferable and shall be of no force and effect if asserted by any person other than such first Buyer. **THE FOREGOING WARRANTY IS EXCLUSIVE AND IN LIEU OF ALL OTHER WARRANTIES WHETHER WRITTEN, ORAL, EXPRESSED OR IMPLIED. THERE ARE NO WARRANTIES OF MERCHANTABILITY OR FITNESS OF ANY PRODUCT FOR A PARTICULAR PURPOSE**

Warranty – Application

HPS does not warrant the accuracy of and results from product or system performance recommendations resulting from any engineering analysis or study. This applies regardless of whether a charge is made for the recommendation, or if it is provided free of charge. Responsibility for selection of the proper product of application rests solely with the Buyer. In the event of errors or inaccuracies determined to be caused by HPS, its liability will be limited to the reperformance of any such analysis or study.

BUYER INSPECTIONS

Tests, inspections and acceptance of all material must be made at the factory. Buyer's inspectors are welcome at the factories and are provided with the necessary facilities for carrying out their work. Name and phone number of who should be contacted for inspection should be given to HPS no later than two weeks prior to scheduled shipment date.

LIMITATION OF LIABILITY

IN NO EVENT AND UNDER NO CIRCUMSTANCES SHALL HPS BE LIABLE TO BUYER OR TO ANY OTHER PERSON FOR ANY INDIRECT, SPECIAL, CONSEQUENTIAL OR INCIDENTAL LOSSES OR DAMAGES, INCLUDING, WITHOUT LIMITATION, DAMAGE TO OR LOSS OF USE OF ANY PRODUCT, LOST SALES, OR PROFITS, OR DELAY OR FAILURE TO PERFORM THIS WARRANTY OBLIGATION, OR CLAIMS OF THIRD PARTIES AGAINST PURCHASER, ARISING OUT OF OR IN CONNECTION WITH THE SALE, INSTALLATION, USE OF, INABILITY TO USE, OR THE REPAIR OR REPLACEMENT OF, HPS' PRODUCTS. As stated herein, the term "person" shall include without limitation, any individual proprietorship, partnership, corporation or entity.

Any claim by Buyer that a product is defective or non-conforming shall be deemed waived by Buyer unless submitted to HPS in writing within thirty (30) days from the date Buyer discovered, or by reasonable inspection should have discovered the alleged defect or non-conformity. Any warranty claim must be brought within one year of discovery of the alleged defect or non-conformity. Upon prompt written notice by the Buyer that a product is defective or non-conforming, HPS' liability shall be limited to repairing or replacing the product, at HPS' option.

1850 Richland Avenue, East, Aiken, SC 29801
HubbellPowerSystems.com
1.573.682.5521 o
1.573.682.8714 f
hpsliterature@hubbell.com

NOTE: Because Hubbell Power Systems Inc., has a policy of continuous product improvement, we reserve the right to change design and specifications without notice.



Introduction

Hubbell introduced the first U.S. non-ceramic arrester in 1986 and continues to be the market leader with a full line of polymer arresters for distribution voltages. The PDV-65 offers cost effective protection for a 5 kA class arrester. The PDV-100 serves the IEC Class 1 arrester market. The Optima disconnecter improves system reliability and increases Temporary Overvoltage (TOV) capability. The Optima line includes Normal Duty (ND), Heavy Duty (HD), Distribution Medium (DM) and Distribution High (DH) arrester products. The PVR Optima targets riser pole and cable applications and the PVI-LP is our IEC Class 2 offering.

As a market leader in arrester technology since 1950, Hubbell has a proven track record of advanced arrester technology, distinguished product quality, and extraordinary customer support that establishes Hubbell as a premier manufacturer of arrester products.

Please note the Ohio Brass Company is a subsidiary of Hubbell Power Systems, Inc. Hubbell Power Systems is a manufacturer of a wide variety of products for transmission and distribution needs of the electric utility industry. Ohio Brass manufactures insulators and arresters for all system voltages and applications, and cable accessories for underground systems.

Basic Construction

Each PDV, PVI-LP and PVR arrester is constructed of a series of MOV (metal oxide varistor) discs that are manufactured by Hubbell in our state-of-the-art plant located in Ohio. Hubbell has 40 years of experience and proven ability in manufacturing these MOV discs, and this in-house capacity allows us to fully control the quality and manufacturing processes. These MOV discs dictate the performance characteristics of the arrester and are locked in place with tightly wound layers of fiberglass filament impregnated with epoxy resin.

Polymer Housing

The arrester housing is made from our proprietary blend of ESP™ silicone alloy. In addition to ESP's exceptional performance as an insulator material, ESP's properties have been confirmed in a series of performance tests that include tracking resistance, contamination, aging, and seal design.

Mounting

The PDV, PVR and PVI-LP arresters can be used with all standard mounting arms and brackets. They are also supplied with all the necessary fasteners, isolators, and terminal attachments. The specially designed fiberglass-filled polyester insulating bracket, with integrated disconnecter, along with optional mounting brackets such as the cross arm or transformer bracket, enable mounting options that best suit every individual customer.

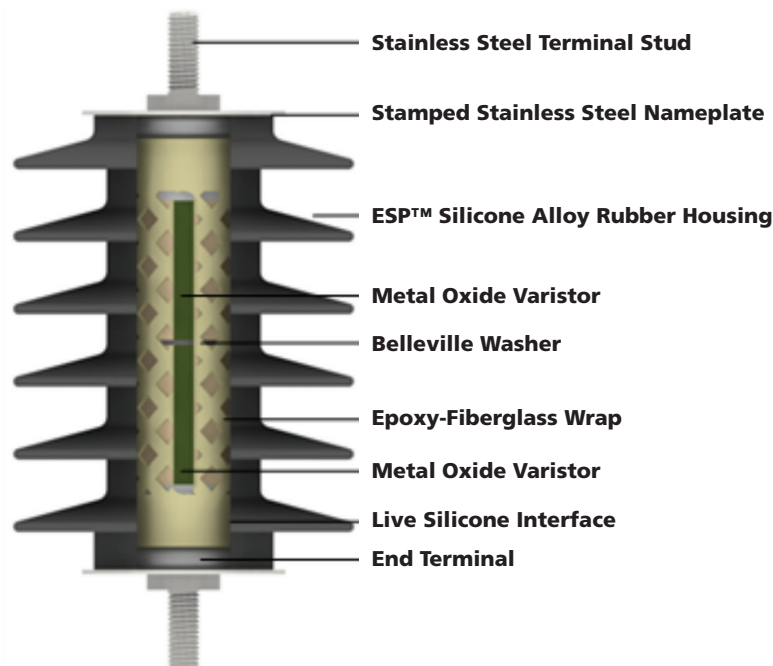

Figure 1: Cutaway view of typical arrester

Rating Selection Considerations

Selection of arrester is based upon the maximum continuous operating voltage (MCOV or U_c) that is applied across the arrester in service (line-to-ground).

- For arresters on effectively grounded systems, this is normally the maximum line-to-ground voltage. (eg. 7.65kV on 12.47kV multi-grounded system.)
- For ungrounded or impedance-grounded systems, the MCOV or U_c should be 90 percent of maximum phase-to-phase voltage or larger.
- Smaller arresters than shown in Table 1 may be used. Contact your Hubbell Power Systems Representative for details.

For convenience, the data shown in this catalog includes the traditional duty-cycle voltage rating associated with the MCOV or U_c of each arrester. The selection of the actual type will be primarily governed by the insulation being protected. In the following pages, select design characteristics from IEC and IEEE arrester standards are discussed. For complete Design Test Reports, refer to the Hubbell Power Systems website.

<http://hubbellpowersystems.com/resources/test-reports/test-reports-arresters.asp>

Table 1: Normally Recommended U_c for Various System Voltages

System Line-to-Line Voltage (kV)		Arrester MCOV or U_c (kV)	
Nominal	Maximum	Effectively Grounded Neutral Circuit	Impedance Grounded & Ungrounded Circuits
2.40	2.54	2.55	2.55
4.16	4.40	2.55	5.10
4.80	5.08	5.10	5.10
6.90	7.26	5.10	7.65
11.00	11.60	7.65	12.70
12.00	12.70	7.65	12.70
12.47	13.20	7.65	15.30
13.20	13.97	8.40	15.30
13.80	14.52	8.40	15.30
20.78	22.00	12.70	22.00
22.00	23.30	15.30	24.40
22.86	24.20	15.30	24.40
23.00	24.34	15.30	24.40
24.94	26.40	15.30	29.00
33.00	34.90	22.00	N/A
34.50	36.51	22.00	N/A

Note: Depending on system grounding conditions, it may be possible to use a lower rating. Consult your Hubbell Power Systems Representative for further information at 1.573.682.5521.

Routine Production Tests

Hubbell maintains stringent process and testing controls to ensure that the customer receives consistent quality with every product. Hubbell also performs various quality assurance tests on every batch of MOV discs. The routine tests listed below, in addition to highly controlled manufacturing processes, ensure that Hubbell products demonstrate a superior level of quality and performance. All arresters are satisfactorily inspected and tested according to IEC 60099-4 Editions 2.2 and 3.0, IEEE C62.11-2012, ISO 9001, quality procedures, and engineering department specifications for MOV gapless arresters.

MOV Disc Routine Tests:

- **Physical Inspection** – Several visual and dimensional checks are performed during the production process including post firing, post grinding, and at final pack out.
- **Rated Energy Test** – This test, not required by standards, confirms the energy capability of 100% of the MOVs produced at Hubbell.
- **Residual Voltage Test** – This test measures the residual voltage of each MOV using an 8/20 current wave impulse.
- **Power Loss Test** – This test, performed on a sample from every batch, measures the power-frequency watts loss and capacitive current characteristics of the disc.

MOV Disc Batch QA Tests:

- **Square Wave Energy Test** (low current long duration)– Performed on a disc sample from each batch, this test is performed to quantify the MOV batch maximum energy capability.
- **High Current Test** (high current short duration)– Each disc sample is subjected to a high current discharge to ensure high current impulse performance.
- **Long Term Stability Under Continuous Ongoing Voltage**– Accelerated aging performance is verified for every batch of MOV discs at a test voltage greater than U_c .

Arrester Routine Tests:

- **Physical Inspection** – Every molded rubber part, MOV disc, wrapped module, bracket and completed unit is visually examined to ensure compliance.
- **Reference Voltage Test** – This test measures the AC voltage once a predetermined maximum peak current is reached. The voltage must be within manufacturing limits.
- **Partial Discharge Test** – This test ensures that the partial discharge level of the arrester does not exceed a level of 10 pC.
- **Power Frequency Test** – This test applies at least 1.25 x MCOV (Maximum Continuous Operating Voltage) to the arrester and measures the power loss (Watts loss). The measured power loss must be below manufacturing limits.
- **Residual/Discharge Voltage** – This test ensures the sum of the resistive elements does not exceed the maximum or less than the minimum predetermined values.



1850 Richland Ave. East; Aiken, South Carolina 29801

Routine Test Report

Customer: Example Power Company Total Quantity Shipped: _____

Customer Purchase Order Number: SAMPLE

Product Description: OPTISIL, IEC DH, 12.7KV UC, 15KV UR MC

Shipper Number: 19358837 Line: 10 Date: 2014-11-11

I hereby certify that all arresters on this order have been satisfactorily inspected and tested according to IEC 60099-4 and ANSI C62.11, ISO 9001, Quality Procedures, and Engineering Department Specifications for MOV gapless arresters.

Tests performed following IEC 60099-4 and ANSI/IEEE C62.11 standards:

1. Residual/Discharge Voltage – Determined by the sum of the resistor elements. Each MOV block was individually tested and rated. Units were built within the range of: 42.1 - 44.1 x MCOV, the unit passes this test if it exhibits a PD level of 10pC or less.
2. Internal Partial Discharge (PD) Test – Test performed with the arrester energized at 1.35 x MCOV, the unit passes this test if it exhibits a PD level of 10pC or less.
3. Reference Voltage – Voltage at which arrester conducts 4.5 mA of peak resistive current. Acceptable ranges are given below.
4. Power Frequency (PF) Test – PF Voltage applied must be at least 1.25 x MCOV. Power loss (Watts Loss) limit given below.
5. Leakage Check – Not applicable per standards (Arresters have <10% gas volume inside).

Arrester Catalog Number	Duty Cycle Rating (kv rms)	MCOV (kv rms)	PD Test Voltage (kVrms)	Reference Voltage (kVpk/√2)		Max Watts Loss
				Min	Max	
SG15024BABB0	15	12.7	13.34	16.56	17.75	9.9

Certified By: 
Alan E. Barrs
QA/CI Engineer

Report Prepared: 11/12/2014

Note: Routine test reports available upon request.



IEC Design Characteristics

1. Long Term Stability Under Continuous Operating Voltage: Ensuring stable arrester performance, after installation, is a necessity. MOV discs are thermally aged at 115°C ± 2°C for 1000 hours, minimum, at voltages specified by standards while continuous measurements of disc watts loss are recorded. Stability is demonstrated with a continuous reduction in watts loss for the entire test period. This test is performed according to the IEC 60099-4 Edition 2.2 and 3.0 standards.

Table 2: Long Term Stability Under Continuous Operating Voltage

Standard	Product	Temperature (°C)	Watts Loss
IEC 60099-4 Edition 2.2	PDV-65	115	Continuously Decreasing
IEC 60099-4 Edition 2.2	PDV-100	115	Continuously Decreasing
IEC 60099-4 Edition 2.2	PVI-LP	115	Continuously Decreasing
IEC 60099-4 Edition 3.0	PDV-65 Optima	115	Continuously Decreasing
IEC 60099-4 Edition 3.0	PDV-100 Optima	115	Continuously Decreasing

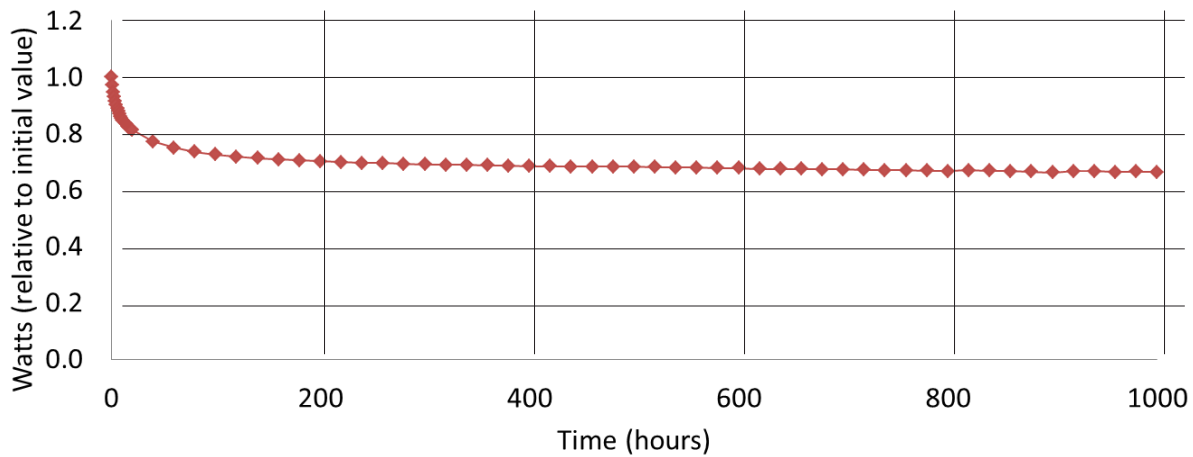

Figure 2: Typical Accelerated Aging/ Long Term Stability Results

2. Heat Dissipation Behavior: The intent of this test is to ensure that the prorated test sample used for durability design tests has a thermal cooling characteristic that is slower than or equal to the actual unit. All prorated samples showed a slower cooling rate than a complete unit, demonstrating sample validity. The test is performed according to the IEC 60099-4 Edition 2.2 and 3.0 standards.

3. Operating Duty Performance: Distribution systems are affected more by lightning strokes than switching operations. The probability of the number of strokes and the magnitude of these strokes depend upon several factors that cannot be controlled or predicted accurately. Hubbell arresters are tested to ensure they are capable of withstanding high current impulses while demonstrating thermal recovery. During this test, the MOV disc test samples are subjected to 20, 8/20 lightning strokes and 4/10 high current impulse of specified magnitude followed by another 8/20 discharge voltage verification impulse. The prorated sections demonstrate thermal stability. Table 3 compares the actual performance of the prorated sections under these test conditions with the tolerances permitted by the standards.

Table 3: Operating Duty Test Characteristics

Standard	Product	4/10 μ s Current Wave(s) (kA)	Maximum Allowable Voltage Change(%)	Actual Voltage Change(%)
IEC 60099-4 2.2	PDV-65	(2) 65	5	2.20
IEC 60099-4 2.2	PDV-100	(2) 100	5	2.65
IEC 60099-4 2.2	PVI-LP	(2) 100	5	0.30
IEC 60099-4 3.0	PDV65-Optima	(1) 65	5	1.80
IEC 60099-4 3.0	PDV100-Optima	(1) 100	5	1.70

4. Disconnecter Operation: It is a common utility practice to attach a ground lead disconnecter to distribution arresters. This is done to ensure continuous system operation in the rare event of an arrester short circuit and to provide a visual indication of the disconnected unit. It is also important to verify that the disconnecter does not operate under surge conditions but isolates the ground lead during arrester short circuit. Samples with disconnecters were subjected to the duty cycle/operating duty test as summarized in Table 3 to verify normal arrester operation under surge conditions. The disconnecter operation under faulted condition was also verified. Table 4, specifies the current sensitivity and the time response of the standard disconnecter. Standards specify the detonation curve be defined for fault currents ranging from 20 to 800 Amps.

Utilities have identified the necessity to have a more sensitive disconnecter which isolates the ground lead at lower current levels. Table 5 specifies the characteristics of the Optima disconnecter. The disconnecter will isolate the ground lead at currents as low as one amp. This has been achieved with a patented capacitor-based disconnecter design instead of the traditional resistor designs. The capacitor-based isolator is more reliable as it prevents thermal run away situations that might be possible with commonly available resistor designs.

Table 4: Resistor Based Disconnecter Characteristics

Current Sensitivity (Amps)	Time to Respond (seconds)
20	1.00
100	0.30
200	0.20
800	0.05

Table 5: Capacitive Based Disconnecter Characteristics

Current Sensitivity (Amps)	Time to Respond (second)
1	7.00
10	1.50
20	0.80
100	0.28
200	0.18
800	0.05

5. Pressure Relief Capability: Hubbell arresters are designed such that, during an unlikely condition of a short circuit, they demonstrate sufficient explosion proof and shatter resistant properties. It is important to consider the symmetrical RMS capability depending on system X/R (reactance to resistance) conditions. Table 6 displays the demonstrated high and low symmetrical RMS current withstands and their durations.

Table 6: Symmetrical Pressure Relief Capability

Standard	Product	High Current Symmetrical RMS (Amps) and Duration (seconds)	Low Current Symmetrical RMS (Amps) and Duration (seconds)
IEC 60099-4 2.2	PDV-65	15,000 & 0.2	600 & 1
IEC 60099-4 2.2	PDV-100	20,000 & 0.2	600 & 1
IEC 60099-4 2.2	PVI-LP	41,000 & 0.2	600 & 1
IEC 60099-4 3.0	PDV-65 Optima	15,000 & 0.2	600 & 1
IEC 60099-4 3.0	PDV-100 Optima	20,000 & 0.2	600 & 1

6. Power Frequency Voltage versus Time Characteristics: Power systems are not ideal and periodically have temporary over voltages (TOV) caused by a variety of reasons. During TOV instances on the system, the arrester will be subject to elevated voltages and therefore higher 60Hz current through the unit. The magnitude and duration of the system generated TOV that the arrester can withstand is best expressed graphically. The three curves in Figure 3 show the TOV capability versus time for the Hubbell arresters in this catalog. The Optima utilizes a capacitance-based isolator which improves the TOV capability while increasing the reliability of disconnecter function. The Optima technology results in a family of TOV curves that are a function of the voltage U_r of the arrester.



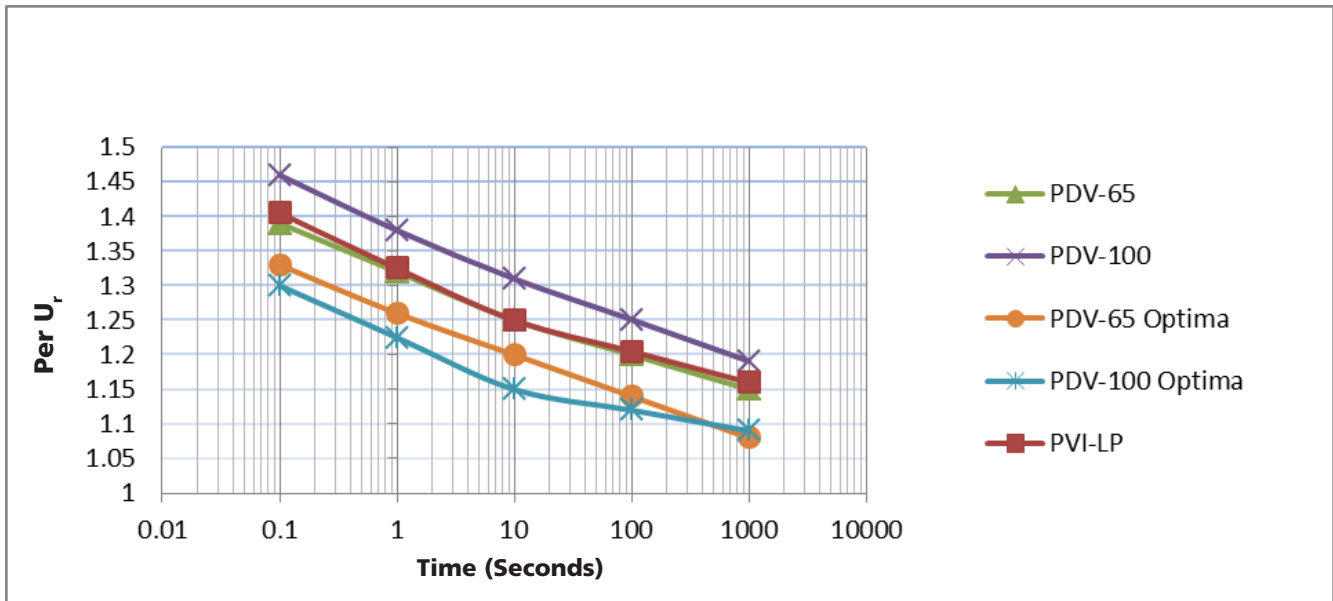

Figure. 3: IEC TOV Capability with no Bracket, No Prior Duty

The conservative mechanical working values shown in Table 7 are for the arrester unit itself. As can be observed, these values are in excess of common requirements. For values of arresters with insulating brackets or any other special condition, please contact your Hubbell Power Systems Representative at 1.573.682.5521.

Table 7: Mechanical Working Values of Arresters

Standard	Product	Cantilever Moment/ Specified Long Term Load [SLL] (Nm)	Specified Short Term Load [SSL] (Nm)	Tension (kN)	Torsion (Nm)	Compression (kN)
IEC 60099-4 2.2	PDV-65	27	N/A	27	27	2.5
IEC 60099-4 2.2	PDV-100	158	N/A	27	27	2.5
IEC 60099-4 2.2	PVI-LP	128	N/A	54	54	2.5
IEC 60099-4 3.0	PDV 65-Optima	34	68	27	27	2.5
IEC 60099-4 3.0	PDV 100-Optima	79	135	27	27	2.5

7. Partial Discharge Performance: Partial discharges in arresters can result in radio interferences and initiate material fatigue that can reduce the life of arresters. The IEC 60099-4 Edition. 2.2 and 3.0 standards require that the arrester shall demonstrate a partial discharge value of less than 10 pC. All Hubbell Power System arresters comply with the standards.

NOTE: The above tests are a portion of the IEC 60099-4 standard requirements. All arresters meet or exceed IEC 60099-4 requirements.

For IEC products, refer to online Design Test Reports on the Hubbell Power Systems website:
<http://www.hubbellpowersystems.com/resources/test-reports/test-reports-arresters.asp>

IEC 5 kA Arrester- PDV-65

The PDV-65 arrester design satisfies the IEC 60099-4 Ed. 2.2 Class 5 kA requirements. Table 8 specifies the electrical characteristics while Table 9 specifies the dimensions, weights, clearances and insulation characteristics of the arrester only configuration.

NOTE: A PDV-65 arrester complete catalog number requires at least ten digits. Common hardware codes can be found in Tables 34 and 35.

Table 8: PDV-65 Arresters Electrical Characteristics

Rated Voltage U_r kV	Continuous Operating Voltage U_c kV	Catalog Number		Residual Voltage kV							
		Imperial hardware	Metric hardware	0.5 μ s Steep front	8/20 Impulse Wave						Switching Surge
					5 kA	1.5 kA	3 kA	5 kA	10 kA	20 kA	
3	2.55	213353	214003	10.6	8.2	8.9	9.2	10.1	11.5	13.6	6.9
6	5.1	213355	214005	20.5	16.4	17.8	18.4	20.2	23.0	27.3	13.9
9	7.65	213358	214008	29.4	23.8	25.8	26.7	29.4	33.4	39.6	20.1
10	8.4	213359	214009	32.7	26.5	28.7	29.7	32.7	37.1	44.0	22.4
12	10.2	213360	214010	38.5	31.3	33.9	35.1	38.6	43.9	52.0	26.5
15	12.7	213363	214013	49.4	40.1	43.3	44.9	49.4	56.1	66.5	33.9
18	15.3	213365	214015	57.6	46.8	50.7	52.5	57.8	65.6	77.8	39.6
21	17.0	213367	214017	64.6	52.6	56.9	59.0	64.9	73.8	87.4	44.5
24	19.5	213370	214020	76.9	62.6	67.7	70.2	77.2	87.8	104.0	52.9
27	22.0	213372	214022	87.9	71.4	77.2	80.0	88.0	100.0	118.6	60.3
30	24.4	213374	214024	97.2	79.1	85.6	88.7	97.6	110.9	131.5	66.9
36	29.0	213379	214029	113.9	92.7	100.3	103.9	114.3	129.9	154	78.3

Table 9: PDV-65 Arresters Dimensions, Clearances and Insulation Withstands

Rated Voltage U_r kV	Continuous Operating Voltage U_c kV	Arrester Only Height mm	Minimum Leakage Distance mm	Minimum Strike Distance mm	Recommended Clearances		Weight kg	Actual BIL Arrester Only kV peak	48-60 Hz Wet WS Arrester Only kV peak
					Phase-Phase	Phase-Ground			
					mm	mm			
3	2.55	140	390	155	127	76	1.6	125	34
6	5.1	140	390	155	137	86	1.6	125	34
9	7.65	140	390	155	152	102	1.6	125	34
10	8.4	140	390	155	157	107	1.6	125	34
12	10.2	140	390	155	191	140	1.7	125	34
15	12.7	216	645	245	216	165	2.5	180	50
18	15.3	216	645	245	241	191	2.5	180	50
21	17	216	645	245	254	203	2.6	180	50
24	19.5	277	780	285	305	254	3.0	210	65
27	22	354	1035	360	330	279	4.0	230	82
30	24.4	354	1035	360	356	305	4.1	230	82
36	29	430	1290	450	419	368	4.8	250	100

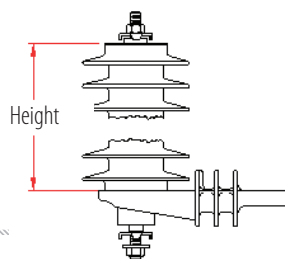

IEC 10kA Class 1 Arrester- PDV-100

The PDV-100 design satisfies the IEC 60099-4 Ed. 2.2 Class 1 requirements. Table 10 specifies the electrical characteristics while Tables 11 and 12 specify the dimensions, weights, clearances and insulation characteristics of the arrester only configuration.

NOTE: A PDV-100 arrester complete catalog number requires at least ten digits. Common hardware codes can be found in Tables 34 and 35.

Table 10: PDV-100 Arresters Electrical Characteristics

Rated Voltage U_r kV	Continuous Operating Voltage U_c kV	Catalog Number		Residual Voltage kV							Switching Surge 0.5 kA
		Imperial hardware	Metric hardware	0.5 μ s Steep front 10 kA	8/20 Impulse Wave						
					1.5 kA	3 kA	5 kA	10 kA	20 kA	40 kA	
3	2.55	213203	214203	10.9	8.0	8.7	9.1	10.1	11.6	13.7	7.4
6	5.1	213205	214205	20.5	15.2	16.4	17.3	19.1	21.9	25.9	14.1
9	7.65	213208	214208	29.1	21.5	23.2	24.5	27.0	30.1	36.6	19.9
10	8.4	213209	214209	32.3	23.9	25.7	27.2	30.0	34.4	40.6	22.1
12	10	213210	214210	36.8	27.3	29.4	31.0	34.3	39.3	46.4	25.2
15	12.7	213213	214213	46.0	34.0	36.7	38.7	42.8	49.0	57.9	31.5
18	15.3	213215	214215	56.7	41.9	45.2	47.7	52.7	60.4	71.4	38.8
21	17	213217	214217	64.5	48.0	51.3	53.4	60.0	68.2	80.2	44.2
24	19.5	213220	214220	73.6	54.6	58.7	62.0	68.5	78.6	92.8	50.4
27	22	213222	214222	82.9	61.4	66.1	69.8	77.1	88.4	104.4	56.7
30	24.4	213224	214224	91.9	68.1	73.3	77.4	85.5	98.1	115.8	62.9
36	29	213230	214230	114.0	84.4	90.8	95.9	106.0	121.6	143.5	77.6
42	33	213233	214233	129.0	96.0	102.4	106.8	120.0	136.4	162.4	88.3
45	36.5	213236	214236	138.0	102.0	109.8	116.1	128.4	147.0	173.7	94.5
48	39	213240	214240	148.7	109.9	118.4	125.1	138.3	158.4	187.2	101.8

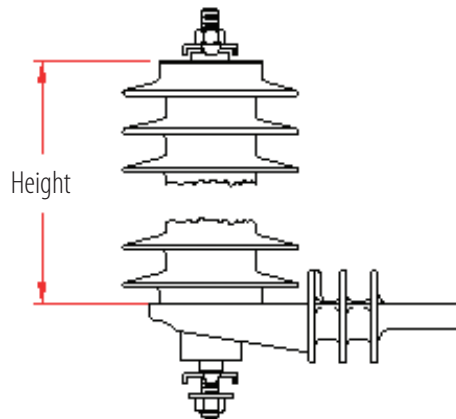

Table 11: PDV-100 Arresters Dimensions, Clearances and Insulation Withstands (WS)

Rated Voltage U_r	Continuous Operating Voltage U_c	Imperial Catalog Number	Arrester Only Height	Minimum Leakage Distance	Minimum Strike Distance	Recommended Clearances		Weight	Actual BIL Arrester Only	48-62 Hz Wet WS Arrester Only
						Phase-Phase	Phase-Ground			
kV	kV		mm	mm	mm	mm	mm	kg	kV peak	kV peak
3	2.55	213203	140	390	155	127	76	1.9	125	34
6	5.1	213205	140	390	155	137	86	1.9	125	34
9	7.65	213208	140	390	155	152	102	1.9	125	34
10	8.4	213209	140	390	155	157	107	1.9	125	34
12	10.2	213210	140	390	155	191	140	2.0	125	34
15	12.7	213213	216	660	245	216	165	2.6	180	50
18	15.3	213215	216	660	245	241	191	2.6	180	50
21	17	213217	216	660	245	254	203	2.8	180	50
24	19.5	213220	274	780	285	270	220	3.4	210	65
27	22	213222	437	1320	455	280	230	4.4	250	100
30	24.4	213227	437	1320	455	290	240	4.4	250	100
36	29	213230	437	1320	455	330	290	4.9	250	100
42	33	213233	437	1320	451	380	340	4.9	250	100
45	36	213236	643	1981	665	400	370	5.9	400	130
48	39	213240	643	1981	665	430	390	5.9	400	130

Table 12: PDV-100 Arresters Dimensions, Clearances and Insulation Withstands (WS)

Rated Voltage U_r	Continuous Operating Voltage U_c	Metric Catalog Number	Arrester Only Height	Minimum Leakage Distance	Minimum Strike Distance	Recommended Clearances		Weight	BIL Arrester Only	48-62 Hz Wet WS Arrester Only
						Phase-Phase	Phase-Ground			
kV	kV		mm	mm	mm	mm	mm	kg	kV peak	kV peak
3	2.55	214203	140	390	155	127	76	1.9	125	34
6	5.1	214205	140	390	155	137	86	1.9	125	34
9	7.65	214208	140	390	155	152	102	1.9	125	34
10	8.4	214209	140	390	155	157	107	1.9	125	34
12	10.2	214210	275	780	155	191	140	2.8	125	34
15	12.7	214213	275	780	270	216	165	2.8	185	60
18	15.3	214215	275	780	270	241	191	2.8	185	60
21	17	214217	275	780	270	254	203	2.8	185	60
24	19.5	214220	414	1170	400	270	220	4.2	250	90
27	22	214222	414	1170	400	280	230	4.2	250	90
30	24.4	214224	414	1170	400	290	240	4.2	250	90
36	29	214230	548	1560	530	330	290	5.6	325	110
42	33	214233	700	1950	660	380	340	7	390	125
45	36	214236	700	1950	660	400	370	7	390	125
48	39	214240	720	2340	790	430	390	8.2	450	145



IEC 10 kA Class 2 Arrester– PVI-LP

The PVI-LP design satisfies the IEC 60099-4 Edition 2.2 10 kA Class 2 requirements. Table 13 specify the electrical characteristics while Table 14 specify the dimensions, weights, clearances and insulation characteristics of the arrester only configuration.

Note: Insulating bracket only available up to 45kV rated voltage.

Table 13: PVI-LP Arresters Electrical Characteristics

Rated Voltage U_r kV	Continuous Operating Voltage U_c kV	Imperial Catalog Number	Metric Catalog Number	Residual Voltage kV								
				0.5 μ s Steep front 10 kA	8/20 Impulse Wave						Switching Surge	
					1.5 kA	3 kA	5 kA	10 kA	20 kA	40 kA	0.125kA	0.5kA
3	2.55	218403	214503	8.5	6.7	7.1	7.4	8.0	8.9	10.0	5.9	6.3
6	5.1	218405	214505	17.0	13.5	14.3	14.9	16.1	17.8	20.1	11.8	12.6
9	7.65	218408	214508	25.7	20.4	21.5	22.5	24.3	26.9	30.3	17.8	19.1
10	8.4	218409	214509	28.3	22.5	23.7	24.8	26.8	29.7	33.4	19.7	21.0
12	10.2	218410	214510	34.0	27.0	28.5	29.8	32.2	35.6	40.2	23.6	25.2
15	12.7	218413	214513	42.7	33.9	35.8	37.5	40.4	44.7	50.4	29.7	31.7
18	15.3	218415	214515	51.4	40.8	43.1	45.1	48.6	53.8	60.7	35.7	38.1
21	17	218417	214517	56.6	45.0	47.5	49.7	53.6	59.3	66.9	39.3	42.0
24	19.5	218420	214520	68.0	54.0	57.1	59.7	64.4	71.3	80.4	47.3	50.5
27	22	218422	214522	77.1	61.2	64.6	67.6	72.9	80.7	91.0	53.5	57.2
30	24.4	218424	214524	85.0	67.5	71.2	74.5	80.4	89.0	100.3	59.0	63.0
36	29	218429	214529	102.1	81.0	85.6	89.5	96.6	106.9	120.6	70.9	75.7
39	31.5	218431	214531	108.0	85.7	90.5	94.7	102.2	113.1	127.5	75.0	80.1
45	36.5	218436	214536	124.7	99.0	104.5	109.3	118.0	130.6	147.3	86.6	92.5
48	39	218439	214539	136.1	108.1	114.1	119.4	128.8	142.5	160.7	94.5	100.9
54	42	218442	214542	147.3	117.0	123.5	129.2	139.4	154.3	174.0	102.3	109.3
60	48	218448	214548	164.4	130.5	137.9	144.2	155.6	172.2	194.2	114.2	122.0
72	57	218457	214557	198.4	158.0	167.0	174.0	187.7	207.8	235.0	137.8	147.2



Table 14: PVI-LP Dimensions, Clearances and Insulation Withstands (WS)

Rated Voltage U_r	Continuous Operating Voltage U_c	Arrester Only Height	Minimum Leakage Distance	Minimum Strike Distance	Recommended Clearances		Weight	BIL Arrester Only	48-62 Hz Wet WS Arrester Only
					Phase-Phase	Phase-Ground			
kV	kV	mm	mm	mm	mm	mm	kg	kV peak	kV peak
3	2.55	140	390	140	127	76	2.1	11	6.7
6	5.1	140	390	140	135	84	2.1	21	13.5
9	7.65	140	390	140	147	97	2.1	32	20.3
10	8.4	140	390	140	152	102	2.1	35	22.4
12	10.2	140	390	140	185	135	2.1	42	26.8
15	12.7	276	780	272	211	160	3.8	53	33.7
18	15.3	276	780	272	234	183	3.8	63	40.6
21	17	276	780	272	246	196	3.8	70	44.7
24	19.5	276	780	272	295	244	3.8	84	53.7
27	22	415	1170	404	318	267	5.6	95	60.8
30	24.4	415	1170	404	343	292	5.6	105	67.1
36	29	415	1170	404	406	356	5.6	126	80.5
39	31.5	551	1565	536	325	290	8.4	133	85.3
45	36.5	551	1565	536	325	290	8.4	154	98.4
48	39	551	1565	536	325	290	8.4	168	107.4
54	42	721	1955	688	401	366	10.6	182	116.3
60	48	721	1955	688	401	366	10.6	203	129.7
72	57	859	2340	800	503	467	11.8	205	156.6

IEC 5 kA Distribution Medium (DM)– PDV-65 Optima

The PDV-65 Optima arrester design satisfies the IEC 60099-4 Edition 3.0 DM requirements. Table 15 specifies the electrical characteristics while Table 16 specifies the dimensions, weights, clearances and insulation characteristics of the arrester only configuration.

NOTE: A PDV-65 Optima arrester complete catalog number requires at least ten digits. Common hardware codes can be found in Tables 34 and 35.

Table 15: PDV-65 Optima Electrical Characteristics

Rated Voltage U_r kV	Continuous Operating Voltage U_c kV	Catalog Number		Residual Voltage kV							
		Imperial hardware	Metric hardware	0.5 μ s Steep front 5 kA	8/20 Impulse Wave						Switching Surge 0.5 kA
					1.5 kA	3 kA	5 kA	10 kA	20 kA	40 kA	
3	2.55	217253	294003	10.5	8.1	8.7	9.2	10.4	12.0	15.0	7.3
6	5.1	217255	294005	20.7	16.3	17.3	18.5	20.8	24.0	30.0	14.6
9	7.65	217258	294008	30.0	23.6	25.1	26.8	30.2	34.9	43.6	21.1
10	8.4	217259	294009	33.3	26.3	28.0	29.8	33.6	38.8	48.5	23.5
12	10.2	217560	294010	39.8	31.5	33.5	35.7	40.2	46.5	58.1	28.1
15	12.7	213263	294013	50.6	39.9	42.5	45.3	51.0	58.9	73.7	35.7
18	15.3	213265	294015	59.7	47.2	50.3	53.6	60.3	69.7	87.1	42.2
21	17	213267	294017	67.2	53.2	56.6	60.3	67.9	78.5	98.1	47.5
24	19.5	217570	294020	79.7	62.9	67.0	71.4	80.4	92.9	116.2	56.3
27	22	213272	294022	89.6	70.8	75.4	80.4	90.5	104.6	130.7	63.3
30	24.4	213274	294024	99.5	78.7	83.8	89.3	100.6	116.2	145.2	70.4
36	29	213279	294029	119.3	94.4	100.5	107.2	120.7	139.4	174.3	84.5

Table 16: PDV-65 Optima Dimensions, Clearances and Insulation Withstands (WS)

Rated Voltage U_r kV	Continuous Operating Voltage U_c kV	Arrester Only Height mm	Minimum Leakage Distance mm	Minimum Strike Distance mm	Recommended Clearances		Weight kg	BIL Arrester Only kV peak	48-62 Hz Wet WS Arrester Only kV peak
					Phase-Phase mm	Phase-Ground mm			
3	2.55	140	390	155	127	76	1.6	125	34
6	5.1	140	390	155	137	86	1.6	125	34
9	7.65	140	390	155	152	102	1.6	125	34
10	8.4	140	390	155	157	107	1.6	125	34
12	10.2	140	390	155	191	140	1.7	125	34
15	12.7	216	645	245	216	165	2.5	180	50
18	15.3	216	645	245	241	191	2.5	180	50
21	17.0	216	645	245	254	203	2.6	180	50
24	19.5	277	780	285	305	254	3.0	210	65
27	22.0	354	1035	360	330	279	4.0	230	82
30	24.4	354	1035	360	356	305	4.1	230	82
36	29.0	430	1290	450	419	368	4.8	250	100

IEC 10 kA Distribution High (DH) Arrester – PDV-100 Optima

The PDV-100 Optima design satisfies the IEC 60099-4 Edition 3.0 DH requirement. Table 17 specifies the electrical characteristics while Table 18 specifies the dimensions, weights, clearances and insulation characteristics of the arrester only configuration.

NOTE: A PDV-100 arrester complete catalog number requires at least ten digits. Common hardware codes can be found in Tables 34 and 35.

Table 17: PDV-100 Optima Arresters Electrical Characteristics

Rated Voltage U_r kV	Continuous Operating Voltage U_c kV	Catalog Number		Residual Voltage kV							
		Imperial hardware	Metric hardware	0.5 μ s Steep front 10 kA	8/20 Impulse Wave						Switching Surge 0.5 kA
					1.5 kA	3 kA	5 kA	10 kA	20 kA	40 kA	
3	2.55	213703	294203	11.5	8.0	8.6	9.1	9.9	11.2	13.3	7.3
6	5.1	213705	294205	22.4	16.0	17.1	18.2	19.8	22.5	26.5	14.7
9	7.65	213708	294208	32.7	23.5	25.1	26.6	29.0	32.9	38.8	21.5
10	8.4	213709	294209	35.5	25.6	27.4	29.0	31.6	35.9	42.3	23.4
12	10.2	213710	294210	42.1	30.4	32.6	34.5	37.6	42.7	50.3	27.8
15	12.7	213713	294213	53.8	38.7	41.4	43.8	47.8	54.3	64.0	35.4
18	15.3	213715	294215	63.1	45.6	48.8	51.7	56.4	64.1	75.5	41.7
21	17	213717	294217	71.0	51.4	55.0	58.2	63.5	72.1	85.0	47.0
24	19.5	213720	294220	85.5	61.6	66.0	69.9	76.2	86.6	102.0	56.4
27	22	213722	294222	95.9	69.2	74.0	78.4	85.5	97.1	114.5	63.3
30	24.4	213724	294224	105.2	76.0	81.4	86.2	94.0	106.8	125.9	69.6
36	29	213729	294229	126.3	91.3	97.8	103.5	112.9	128.3	151.2	83.5
42	34	213734	294234	134.2	97.1	103.9	110.0	120.0	136.3	160.7	94.0

Table 18: PDV-100 Optima Dimensions, Clearances and Insulation Withstands

Rated Voltage U_r	Continuous Operating Voltage U_c	Arrester Only Height	Minimum Leakage Distance	Minimum Strike Distance	Recommended Clearances		Weight	BIL Arrester Only	48-62 Hz Wet WS Arrester Only
					Phase-Phase	Phase- Ground			
kV	kV	mm	mm	mm	mm	mm	kg	kV peak	kV peak
3	2.55	173	215	141	127	76	1.3	12.8	8.7
6	5.1	193	287	161	137	86	1.5	25.7	17.4
9	7.65	221	365	190	152	102	1.7	37.7	25.5
10	8.4	221	365	190	157	107	1.7	41.1	27.8
12	10.2	236	431	212	191	140	2.0	48.9	33.1
15	12.7	295	640	268	216	165	2.5	62.1	42.1
18	15.3	295	640	268	241	191	2.5	73.3	49.6
21	17	315	713	291	254	203	2.8	82.5	55.9
24	19.5	389	927	360	305	254	3.8	99.1	67.1
27	22	417	1005	385	330	279	4.0	111	75.2
30	24.4	429	1079	400	356	305	4.2	122	82.7
36	29	490	1280	456	419	368	4.7	147	99.4
42	34	533	1428	500	488	500	5.3	165	111.8

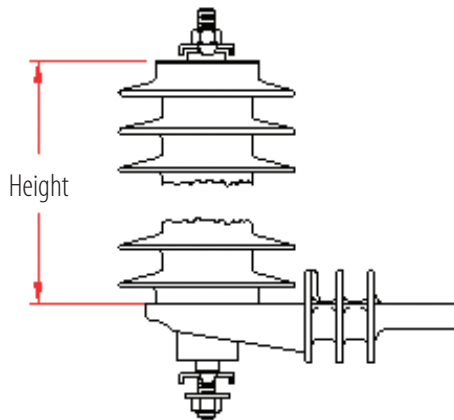

IEEE Design Characteristics

1. Accelerated Aging: Ensuring stable arrester performance, after installation, is a necessity. MOV discs are thermally aged at $115^{\circ}\text{C} \pm 2^{\circ}\text{C}$ for 1000 hours, minimum, at voltages specified by standards while continuous measurements of disc watts loss are recorded. Excellent stability is demonstrated with a continuous reduction in watts loss for the entire test period. This test is performed according to the IEEE C62.11-2012 standard. A typical result is shown in Figure 2 (page 7) of this catalog.

Table 19: Accelerated Aging Performance

Standard	Product	Temperature (°C)	Time (hours)	Watts Loss
IEEE C62.11 2012	PDV-65 Optima	115	1000	Continuously Decreasing
IEEE C62.11 2012	PDV-100 Optima	115	1000	Continuously Decreasing
IEEE C62.11 2012	PVR Optima	115	1000	Continuously Decreasing

2. Thermal Equivalency: The intent of this test is to ensure that the prorated test sample used for durability design tests has a thermal cooling characteristic that is slower than or equal to the actual unit. All prorated samples showed a slower cooling rate than a complete unit, demonstrating sample validity. The test is performed according to the IEEE C62.11-2012 standard.

3. Duty Cycle Test: Hubbell arresters are tested to ensure they are capable of withstanding high current impulses while demonstrating thermal recovery. During this test, the MOV test samples are subjected to twenty, 8/20 lightning strokes and two, 4/10 high current impulses of specified magnitude followed by another 8/20 discharge voltage verification impulse. The prorated sections demonstrated thermal stability. Table 20 compares the actual performance of the prorated sections under these test conditions with the tolerances permitted by the standards.

Table 20: Operating Duty Characteristics

Standard	Product	Two, 4/10 μs Current Waves (kA)	Max Allowable Voltage Change (%)	Actual Voltage Change (%)
IEEE C62.11 2012	PDV-65 Optima	65	10	0.8
IEEE C62.11 2012	PVDV-100 Optima	100	10	1.6
IEEE C62.11 2012	PVR Optima	100	10	1.3

4. Disconnecter Operation: It is a common utility practice to attach a ground lead disconnecter to distribution arresters. This is done to ensure continuous system operation in the rare event of an arrester short circuit and to provide a visual indication of the disconnected unit. It is also important to verify that the disconnecter does not operate under surge conditions but isolates the ground lead during arrester short circuit. Samples with disconnectors were subjected to the duty cycle/operating duty tests as summarized in Table 20 to verify normal arrester operation under surge conditions. The disconnecter operation under faulted condition was also verified. Table 21 specifies the current sensitivity and the time response of the standard disconnecter. Standards specify the detonation curve be defined for fault currents ranging from 20 to 800 Amps.

Utilities have identified the necessity to have a more sensitive disconnecter that isolates the ground lead at lower current levels. Hubbell now offers its advanced disconnecter with all its IEEE C62.11-2012 compliant Optima distribution arresters. Table 22 specifies the characteristics of the Optima disconnecter. The disconnecter will isolate the ground lead at currents as low as one amp. This has been achieved with a patented capacitor-based disconnecter design instead of the traditional resistor design. The capacitor-based isolator is more reliable as it prevents thermal run away situations that might be possible with commonly available resistor designs.



Table 21: Resistor Based Disconnect Characteristics	
Current Sensitivity (Amp)	Time to Operate (Second)
-	-
-	-
20	1
100	0.3
200	0.2
800	0.05

Table 22: Capacitive Based Disconnect Characteristics	
Current Sensitivity (Amp)	Time to Operate (Second)
1	7
10	1.5
20	0.8
100	0.28
200	0.18
800	0.05

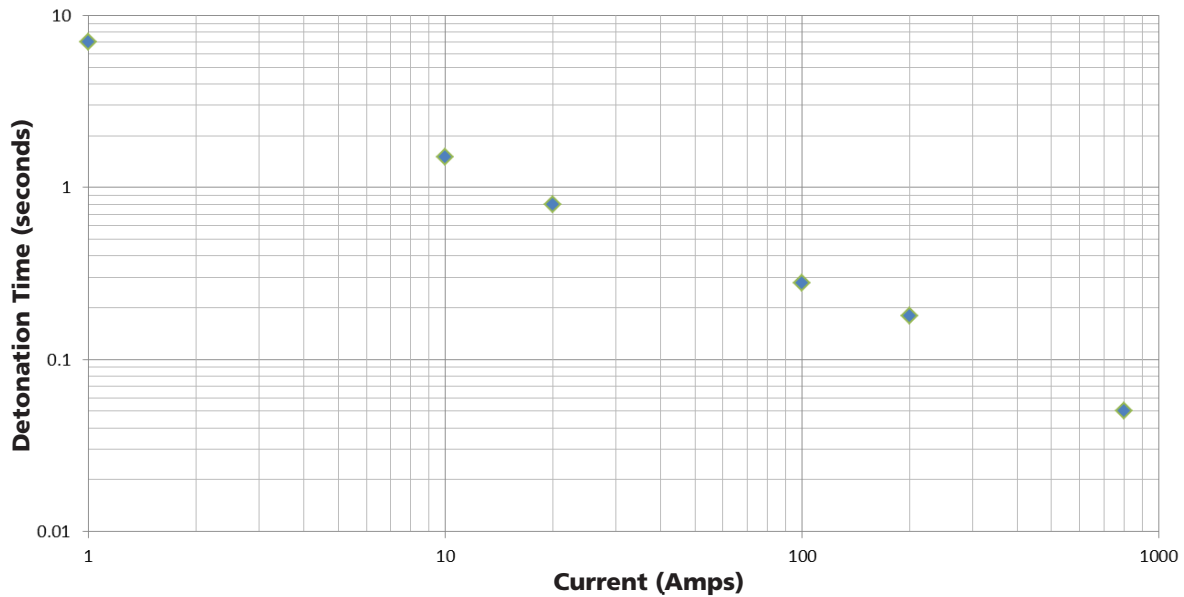

Figure 4: Optima Based Detonation Curve

5. Short Circuit Hubbell arresters are designed such that, during an unlikely condition of a short circuit, they demonstrate sufficient explosion proof and shatter resistant properties. It is important to consider the symmetrical RMS capability depending on system X/R (reactance to resistance) conditions. Table 23 displays the demonstrated high and low symmetrical RMS current withstands and their durations. It can be observed that the asymmetrical peak to the symmetrical peak ratios is greater than 2.5.

Table 23: Symmetrical Pressure Relief Capability			
Standard	Product	High Current Symmetrical RMS (Amps) and Duration (Seconds)	Low Current Symmetrical RMS (Amps) and Duration (Seconds)
IEEE C62.11 2012	PDV-65 Optima	15,000/0.2	600/1
IEEE C62.11 2012	PDV-100 Optima	20,000/0.2	600/1
IEEE C62.11 2012	PVR-Optima	20,000/0.2	600/1



6. Power Frequency Voltage versus Time Characteristics: Power systems are not ideal and periodically have temporary over voltages (TOV) caused by a variety of reasons. During TOV instances on the system, the arrester can see elevated voltages and therefore higher 60Hz current through the unit. The magnitude and duration of the system-generated TOV that the arrester can withstand is best expressed graphically. The three curves in Figure 5 show the TOV capability versus time for the Hubbell arresters in this catalog. The Optima utilizes a capacitance-based isolator which improves the TOV capability while increasing the reliability of disconnecter function. The Optima technology results in a family of TOV curves that are a function of the MCOV of the arrester.

For more information, contact your Hubbell Power Systems Representative at 1.573.682.5521.

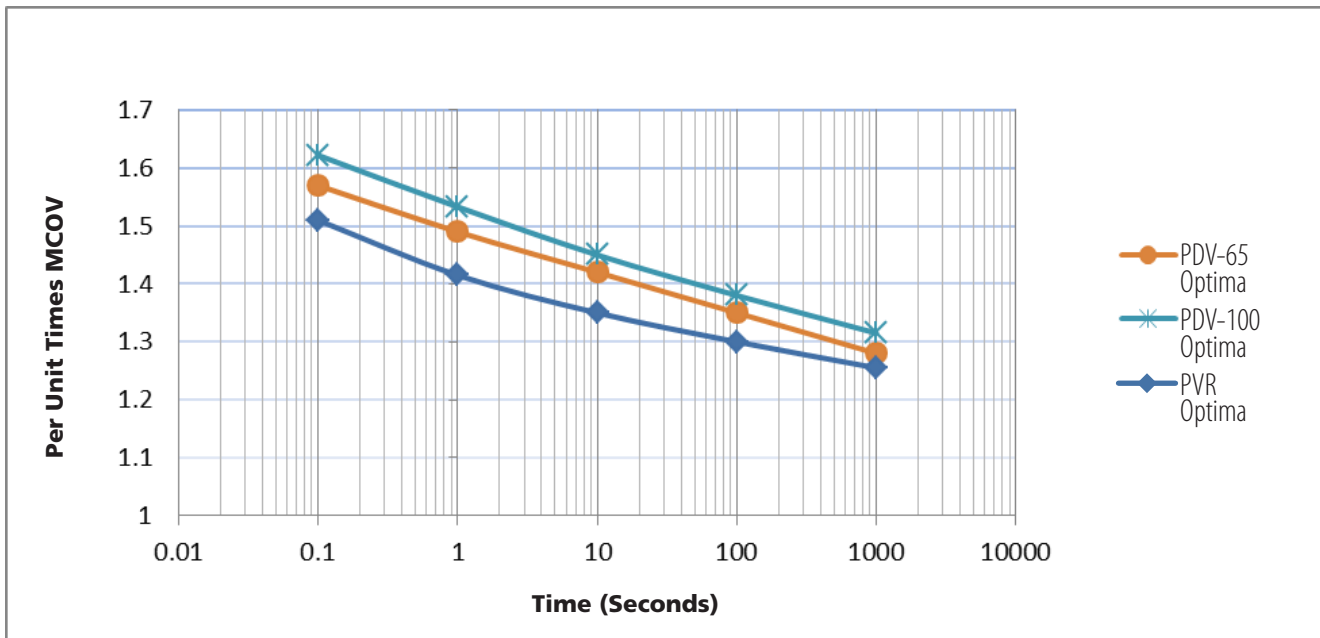

Figure 5: IEEE TOV Capability with no bracket, No Prior Duty

For IEEE products, refer to online Design Test Reports on the Hubbell Power Systems website:
<http://www.hubbellpowersystems.com/resources/test-reports/test-reports-arresters.asp>

Table 24: Mechanical Working Values of Arresters

Standard	Product	Cantilever Moment (Nm)	Tension (kN)	Torsion (Nm)	Compression (kN)
IEEE C62.11 2012	PDV-65 Optima	45	2.5	27	2.5
IEEE C62.11 2012	PDV-100 Optima	80	2.5	27	2.5
IEEE C62.11 2012	PVR Optima	135	2.5	54	2.5



IEEE Normal Duty Distribution Arrester– PDV-65 Optima (ND)

The PDV-65 Optima design satisfies the IEEE C62.11-2012 Normal Duty arrester requirement. Table 25 specifies the electrical characteristics while Table 26 specifies the dimensions, weights, clearances and insulation characteristics of the arrester only configuration.

NOTE: A PDV-65 Optima arrester complete catalog number requires at least ten digits. Common hardware codes can be found in Tables 34 and 35.

Table 25: PDV-65 Optima Electrical Characteristics

Rated Voltage	Maximum Continuous Operating Voltage	Catalog Number	Residual Voltage kV							Switching Surge
			0.5 μ s Steep front	8/20 Impulse Wave						
				5 kA	1.5 kA	3 kA	5 kA	10 kA	20 kA	
kV	kV									
3	2.55	217253	10.1	8.1	8.7	9.2	10.4	12.0	15.0	7.3
6	5.1	217255	20.2	16.3	17.3	18.5	20.8	24.0	30.0	14.6
9	7.65	217258	29.3	23.6	25.1	26.8	30.2	34.9	43.6	21.1
10	8.4	217259	32.6	26.3	28.0	29.8	33.6	38.8	48.5	23.5
12	10.2	217560	39.1	31.5	33.5	35.7	40.2	46.5	58.1	28.1
15	12.7	213263	49.6	39.9	42.5	45.3	51.0	58.9	73.7	35.7
18	15.3	213265	58.7	47.2	50.3	53.6	60.3	69.7	87.1	42.2
21	17	213267	66.1	53.2	56.6	60.3	67.9	78.5	98.1	47.5
24	19.5	217570	78.2	62.9	67.0	71.4	80.4	92.9	116.2	56.3
27	22	213272	88.0	70.8	75.4	80.4	90.5	104.6	130.7	63.3
30	24.4	213274	97.8	78.7	83.8	89.3	100.6	116.2	145.2	70.4
36	29	213279	117.4	94.4	100.5	107.2	120.7	139.4	174.3	84.5

Table 26: PDV-65 Optima Arresters Dimensions, Clearances and Insulation Withstands (WS)

Rated Voltage	Maximum Continuous Operating Voltage	Catalog Number	Arrester Only Height	Minimum Leakage Distance	Minimum Strike Distance	Recommended Clearances		Weight	BIL Arrester Only	48-62 Hz Wet WS Arrester Only
						Phase-Phase	Phase-Ground			
kV	kV		(in)	(in)	(in)	(in)	(in)	(lbs)	kV peak	kV peak
3	2.55	217253	9.3	15.4	6.1	4.8	3.0	3.53	20.3	9.9
6	5.1	217255	9.3	15.4	6.1	5.0	3.2	3.53	40.5	19.8
9	7.7	217258	9.3	15.4	6.1	5.6	3.8	3.53	55.4	29.7
10	8.4	217259	9.3	15.4	6.1	5.8	4.1	3.53	58.9	32.7
12	10.2	217560	9.3	15.4	6.1	7.5	5.7	3.53	80.9	39.7
15	12.7	213263	12.3	25.5	9.7	8.5	6.7	5.29	88.6	49.4
18	15.3	213265	12.3	25.5	9.7	9.5	7.7	5.29	103.1	59.5
21	17	213267	12.3	25.5	9.7	10.0	8.2	5.29	112.2	66.1
24	19.5	217570	14.7	30.8	11.5	12.0	10.2	7.72	139.3	75.8
27	22	213272	17.7	40.9	15.0	13.0	11.3	7.72	158.3	85.5
30	24.4	213274	17.7	40.9	15.0	13.6	11.8	7.72	182.8	94.9
36	29	213279	20.7	51.0	18.2	16.2	14.4	9.26	221.5	112.8

IEEE Heavy Duty Distribution Arrester– PDV-100 Optima (HD)

The PDV-100 Optima design satisfies the IEEE C62.11-2012 Heavy Duty arrester requirement. Table 27 specifies the electrical characteristics while Table 28 specifies the dimensions, weights, clearances and insulation characteristics of the arrester only configuration.

NOTE: A PDV-100 Optima arrester complete catalog number requires at least ten digits. Common hardware codes can be found in Tables 34 and 35.

Table 27: PDV-100 Optima Arresters Electrical Characteristics

Rated Voltage	Maximum Continuous Operating Voltage	Catalog Number	Residual Voltage kV							Switching Surge
			0.5 μ s Steep front	8/20 Impulse Wave						
				10 kA	1.5 kA	3 kA	5 kA	10 kA	20 kA	
kV	kV		10 kA	1.5 kA	3 kA	5 kA	10 kA	20 kA	40 kA	0.5kA
3	2.55	213703	10.7	8.0	8.6	9.1	9.9	11.2	13.3	7.3
6	5.1	213705	21.5	16.0	17.1	18.2	19.8	22.5	26.5	14.7
9	7.65	213708	31.4	23.5	25.1	26.6	29.0	32.9	38.8	21.5
10	8.4	213709	34.3	25.6	27.4	29.0	31.6	35.9	42.3	23.4
12	10.2	213710	40.8	30.4	32.6	34.5	37.6	42.7	50.3	27.8
15	12.7	213713	51.8	38.7	41.4	43.8	47.8	54.3	64.0	35.4
18	15.3	213715	61.1	45.6	48.8	51.7	56.4	64.1	75.5	41.7
21	17	213717	68.8	51.4	55.0	58.2	63.5	72.1	85.0	47.0
24	19.5	213720	82.6	61.6	66.0	69.9	76.2	86.6	102.0	56.4
27	22	213722	92.7	69.2	74.0	78.4	85.5	97.1	114.5	63.3
30	24.4	213724	101.9	76.0	81.4	86.2	94.0	106.8	125.9	69.6
36	29	213729	122.4	91.3	97.8	103.5	112.9	128.3	151.2	83.5

Table 28: PDV-100 Optima Arresters Dimensions, Clearances and Insulation Withstands (WS)

Rated Voltage	Maximum Continuous Operating Voltage	Catalog Number	Arrester Only Height	Minimum Leakage Distance	Minimum Strike Distance	Recommended Clearances		Weight	BIL Arrester Only	48-62 Hz Wet WS Arrester Only
						Phase-Phase	Phase-Ground			
						(in)	(in)			
kV	kV		(in)	(in)	(in)	(in)	(in)	(lbs)	kV peak	kV peak
3	2.55	213703	6.8	8.5	3.8	5.0	3.0	2.87	15.8	5.0
6	5.1	213705	7.6	11.3	4.6	5.4	3.4	3.31	31.7	10.1
9	7.65	213708	8.7	14.4	5.7	6.0	4.0	3.75	46.3	15.1
10	8.4	213709	8.7	14.4	5.7	6.2	4.2	3.75	50.6	16.6
12	10.2	213710	9.3	17.0	6.6	7.5	5.5	4.41	60.1	20.1
15	12.7	213713	11.6	25.2	8.8	8.5	6.5	5.51	76.4	25.0
18	15.3	213715	11.6	25.2	8.8	9.5	7.5	5.51	90.2	30.2
21	17	213717	12.4	28.1	9.7	10.0	8.0	6.17	101.4	33.5
24	19.5	213720	15.3	36.5	12.4	12.0	10.0	8.38	121.7	38.5
27	22	213722	16.4	39.6	13.4	13.0	11.0	8.82	136.6	43.4
30	24.4	213724	16.9	42.5	14.0	14.0	12.0	9.26	150.2	48.1
36	29	213729	19.3	50.4	16.2	16.5	14.5	10.36	180.3	57.2



IEEE Riser Pole Distribution Arrester– PVR-Optima

The PVR-Optima design satisfies the IEEE C62.11-2012 Riser Pole heavy-duty arrester requirement. Table 29 specifies the electrical characteristics while Table 30 specifies the dimensions, weights, clearances and insulation characteristics of the arrester only configuration.

NOTE: A PVR Optima arrester complete catalog number requires at least ten digits. Common hardware codes can be found in Tables 34 and 35.

Table 29: PVR Optima Arresters Electrical Characteristics

Rated Voltage	Maximum Continuous Operating Voltage	Catalog Number	Residual Voltage kV							
			0.5 μ s Steep front	8/20 Impulse Wave						Switching Surge
				10 kA	1.5 kA	3 kA	5 kA	10 kA	20 kA	
kV	kV		10 kA	1.5 kA	3 kA	5 kA	10 kA	20 kA	40 kA	0.5kA
3	2.55	221603	10.5	7.8	8.1	8.4	9.1	10.1	11.6	7.2
6	5.1	221605	21.0	15.6	16.3	17.0	18.3	20.2	23.4	14.4
9	7.65	221608	27.6	20.9	21.8	22.7	24.5	27.1	31.4	19.4
10	8.4	221609	30.3	23.1	24.1	25.1	27.0	29.8	34.6	21.3
12	10.2	221610	36.2	27.8	29.0	30.2	32.5	35.9	41.6	25.7
15	12.7	221613	45.5	34.6	36.1	37.6	40.5	44.8	51.8	32.1
18	15.3	221615	54.5	41.8	43.6	45.4	48.9	54.0	62.6	38.7
21	17	221617	61.7	47.5	49.5	51.6	55.6	61.4	71.2	43.8
24	19.5	221620	72.2	55.5	57.8	60.2	64.9	71.7	83.1	51.3
27	22	221622	81.4	61.6	64.2	66.8	72.0	79.6	92.2	56.6
30	24.4	221624	91.0	69.3	72.2	75.2	81.0	89.5	103.7	64.0
36	29	221629	107.2	82.2	85.6	89.2	96.1	106.2	123.0	75.7



Table 30: PVR Optima Arresters Dimensions, Clearances and Insulation Withstands (WS)

Rated Voltage	Maximum Continuous Operating Voltage	Catalog Number	Arrester Only Height	Minimum Leakage Distance	Minimum Strike Distance	Recommended Clearances		Weight	BIL Arrester Only	48-62 Hz Wet WS Arrester Only
						Phase-Phase	Phase-Ground			
kV	kV		(in)	(in)	(in)	(in)	(in)	(lbs)	kV peak	kV peak
3	2.55	221603	7.0	8.0	2.9	5.0	3.0	3.3	14.8	4.8
6	5.1	221605	9.4	15.4	6.1	5.3	3.3	4.2	29.8	9.6
9	7.65	221608	9.4	15.4	6.1	5.8	3.8	4.2	39.9	14.4
10	8.4	221609	9.4	15.4	6.1	6.0	4.0	4.2	44.0	15.8
12	10.2	221610	9.4	15.4	6.1	7.3	5.3	4.4	53.0	19.1
15	12.7	221613	12.4	26.0	9.7	8.3	6.3	5.5	66.0	23.8
18	15.3	221615	12.4	26.0	9.7	9.2	7.2	6.2	79.7	28.7
21	17	221617	12.4	26.0	9.7	9.7	7.7	6.2	90.6	31.9
24	19.5	221620	14.7	30.8	11.3	11.6	9.6	7.5	105.6	36.6
27	22	221622	21.1	52.0	18.0	12.5	10.5	9.7	117.3	41.3
30	24.4	221624	21.1	52.0	18.0	13.5	11.5	9.7	131.9	45.8
36	29	221629	21.1	52.0	18.0	16.0	14.0	10.8	156.2	54.4

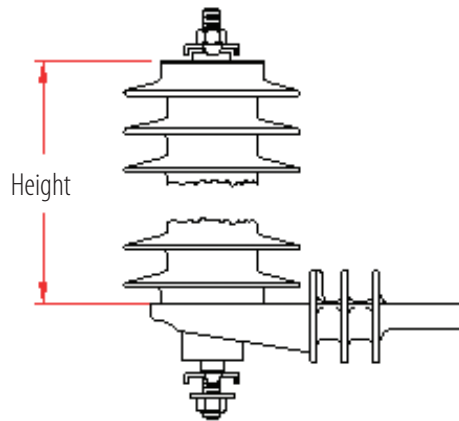

Arrester Accessories

Insulating Base Brackets: Utilities can cut the cost of providing a standoff insulator for arrester support by choosing the cost effective optional insulating base bracket along with the arrester. Table 31 illustrates the electrical parameters. Table 32 shows the standard brackets for each Hubbell arrester. The bracket drawings below show the available insulating base brackets. For special locations with extreme contamination levels, please contact your Hubbell Power Systems Representative for additional bracket and hardware options.

Table 31:
Insulating Bracket Electrical Parameters

Bracket Type	Insulation withstand kV		
	BIL kV 1.2/50	Power Frequency Withstand kV	
		Dry	Wet
Short	75	40	20
Medium	80	45	25
Long	95	50	30

Table 32:
Standard Bracket Selection Criteria

Bracket Size	MCOV Range kV	Duty Rated Range kV	Leakage (Distance)
Short	2.55 to 10.2	3 to 12	111mm
Medium	12.7 to 19.5	15 to 24	184mm
Long	22 to 36	27 to 45	235mm

The insulating bracket cannot be used for arresters with a MCOV larger than 36 kV and rated voltage above 45kV.

Note: Insulating bracket ranges reflect minimum bracket requirements.

Bracket Drawings

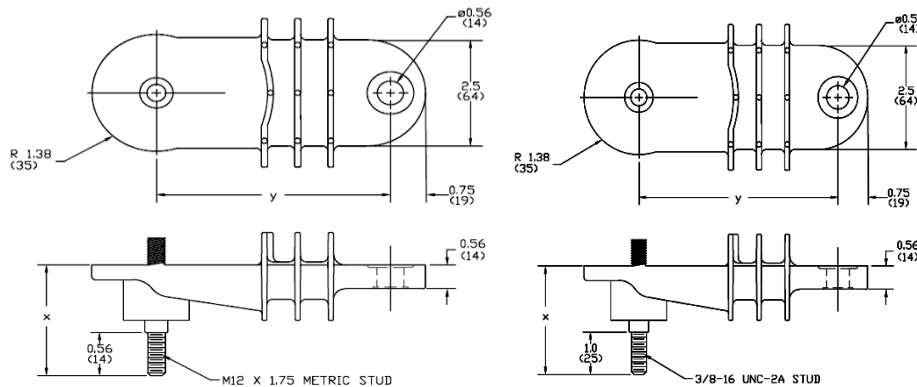

M12 Stud

Dimensions: Inches (mm)

	Short	Medium	Long		Short	Medium	Long
x	67 mm	66 mm	67 mm	x	2.62 in.	2.60 in	2.62 in
y	108 mm	127 mm	152 mm	y	4.25 in.	5.00 in	6.00 in

3/8in Stud

Dimensions: Inches (mm)

Terminals: All terminals are solderless, clamp type, suitable for conductor sizes from No. 6 AWG solid to No. 2 AWG stranded. If the spacing of the mounting holes on insulating brackets listed is not suitable for the intended application, other mounting brackets are available and in these cases, the Hubbell Power Systems representative should be consulted. 1.573.682.5521

Ordering

Arresters are identified by a part number with a minimum of ten digits. Choose the appropriate first six digits of the arrester shown in the "Catalog Number" column of the electrical characteristics table in the previous pages. Based on the hardware configuration, please select your choice of the last four digits. The following tables show common available hardware for each arrester group in imperial or metric configurations.

- For an IEC PDV-100 arrester of 8.4 kV Uc without any hardware, the catalog number would be 214209-CCAA.
- For an IEEE PDV-100 Optima of 8.4 kV Uc with basic hardware the catalog number is 213709-7202.

Table 33: Available Arrester Hardware

Standard	Product	Prefix Codes	Imperial Hardware Configuration	Metric Hardware Configuration
IEC60099-4 Edition 2.2	PDV-65	2133XX	√	
IEC60099-4 Edition 2.2	PDV-65	2140XX		√
IEC60099-4 Edition 2.2	PDV-100	2132XX	√	
IEC60099-4 Edition 2.2	PDV-100	2142XX		√
IEC60099-4 Edition 2.2	PVI-LP	2184XX	√	
IEC60099-4 Edition 2.2	PDV-100	2142XX		√
IEC60099-4 Edition 2.2	PVI-LP	2145XX		√
IEC60099-4 Edition 3.0	PDV-65 Optima	2940XX		√
IEC60099-4 Edition 3.0	PDV-65 Optima	2132XX* / 2175XX	√	
IEC60099-4 Edition 3.0	PDV-100 Optima	2942XX		√
IEC60099-4 Edition 3.0	PDV-100 Optima	2137XX	√	
IEEE C62. 11-2012	PDV-65 Optima	2132XX* / 2175XX	√	
IEEE C62. 11-2012	PDV-65 Optima	2940XX		√
IEEE C62. 11-2012	PDV-100 Optima	2137XX	√	
IEEE C62. 11-2012	PDV-100 Optima	2942XX		√
IEEE C62. 11-2012	PVR Optima	2216XX	√	

*Only applies to the following MCOV values: 2.55, 5.1, 7.65, 8.4, 10.2, and 19.5

Common Metric Hardware Options



Hardware Code C1BC



Hardware Code CVBX



Hardware Code C1CC

Table 34: Common Metric Hardware Configurations

Suffix	Top Hardware	Mounting Hardware	Bottom Hardware
CAA	No Accessories	No Insulating Bracket	No accessories
CCBE	Hex Nut & Wire Clamp	No Insulating Bracket	Hex Nut, Wire Clamp, 2 Washers, No Isolator
CCBI	Hex Nut & Wire Clamp	No Insulating Bracket	Hex Nut, Wire Clamp, 2 Washers, Ground Strap, NEMA Bracket
CLBC*	Hex Nut & Wire Clamp	Short Insulating Bracket with Disconnecter	Hex Nut, Wire Clamp, Washer
C1BC*	Hex Nut & Wire Clamp	Medium Insulating Bracket with Disconnecter	Hex Nut, Wire Clamp, Washer
C1CC*	Hex Nut, Wire Clamp & Protective Cap	Medium Insulating Bracket with Disconnecter	Hex Nut, Wire Clamp, Washer
CVBC*	Hex Nut & Wire Clamp	Long Insulating Bracket with Disconnecter	Hex Nut, Wire Clamp, Washer
CVBX	Hex Nut & Wire Clamp	Long Insulating Bracket with Disconnecter	Hex Nut, Flatwasher, 457mm Lead Wire, NEMA Bracket

*To add a protective cap, change the BC to CC

*Insulating bracket selection on Table 32

Note: Depending on system grounding conditions, it may be possible to use a lower rating. Consult your Hubbell Power Systems Representative for further information at 1.573.682.5521.

Common Imperial Hardware Options

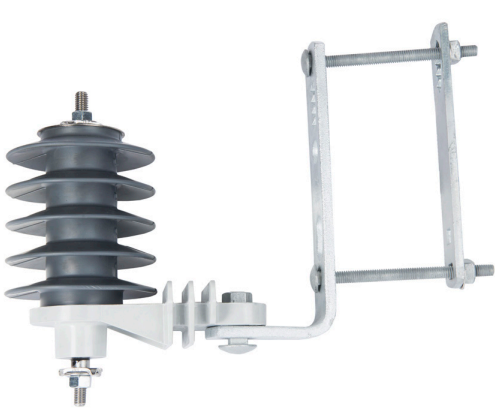

Hardware Code 7224



Hardware Code 7233



Hardware Code 7314

Table 35: Common Imperial Hardware Configurations

Suffix	Top Hardware	Mounting Hardware	Bottom Hardware
7202	Hex Nut & Wire Clamp	None	Hex Nut, Wire Clamp, & Flat Washer
7213	Hex Nut & Wire Clamp	Insulating Bracket	Isolator, Hex Nut, Flat Washer & Ground Strap
7214	Hex Nut & Wire Clamp	Insulating Bracket	Isolator, Hex Nut, Wire Clamp, Flat Washer & Nylon Retainer Washer
7224	Hex Nut & Wire Clamp	Insulating Bracket & NEMA 4x5 X-Arm Bracket	Isolator, Hex Nut, Wire Clamp, Flat Washer & Nylon Retainer Washer
7234	Hex Nut & Wire Clamp	Insulating Bracket & Transformer Bracket	Isolator, Hex Nut, Wire Clamp, Flat Washer & Nylon Retainer Washer
7233	Hex Nut & Wire Clamp	Insulating Bracket & Transformer Bracket	Isolator, Hex Nut, Flat Washer & Ground Strap
7254	Hex Nut & Wire Clamp	Insulating Bracket, & Bracket Assembly 6x6 Arm	Isolator, Hex Nut, Flat Washer & Nylon Retainer Washer
7313	Hex Nut, Wire Clamp, & Protective Cap	Insulating Bracket	Isolator, Hex Nut, Flat Washer & Ground Strap
7314	Hex Nut, Wire Clamp, & Protective Cap	Insulating Bracket	Isolator, Hex Nut, Wire Clamp, Flat Washer & Nylon Retainer Washer
7323	Hex Nut, Wire Clamp, & Protective Cap	Insulating Bracket & NEMA 4x5 X-Arm Bracket	Hex Nut, Flat Washer & Ground Strap
7324	Hex Nut, Wire Clamp, & Protective Cap	Insulating Bracket & NEMA 4x5 X-Arm Bracket	Isolator, Hex Nut, Wire Clamp, Flat Washer & Nylon Retainer Washer
7334	Hex Nut, Wire Clamp, & Protective Cap	Insulating Bracket & Transformer Bracket	Isolator, Hex Nut, Wire Clamp, Flat Washer & Nylon Retainer Washer
7333	Hex Nut, Wire Clamp, & Protective Cap	Insulating Bracket & Transformer Bracket	Isolator, Hex Nut, Flat Washer & Ground Strap
7354	Hex Nut, Wire Clamp, & Protective Cap	Insulating Bracket, & Bracket Assembly 6x6 Arm	Isolator, Hex Nut, Flat Washer & Nylon Retainer Washer
7514	Hex Nut, Wire Clamp, Protective Cap, & 18" Lead Wire	Insulating Bracket	Isolator, Hex Nut, Wire Clamp, Flat Washer & Nylon Retainer Washer
7533	Hex Nut, Wire Clamp, Protective Cap, & 18" Lead Wire	Insulating Bracket & Transformer Bracket	Isolator, Hex Nut, Flat Washer & Ground Strap
7534	Hex Nut, Wire Clamp, Protective Cap, & 18" Lead Wire	Insulating Bracket & Transformer Bracket	Isolator, Hex Nut, Wire Clamp, Flat Washer & Nylon Retainer Washer

Note: Depending on system grounding conditions, it may be possible to use a lower rating. Consult your Hubbell Power Systems Representative for further information at 1.573.682.5521.



Protective Caps

Universal Optima Cap: The Optima line imperial protective cap shown is designed for single or through connection lead wires. Each side of the cap has webbed fingers that prevent accidental contact with the arrester top end hardware by wildlife.

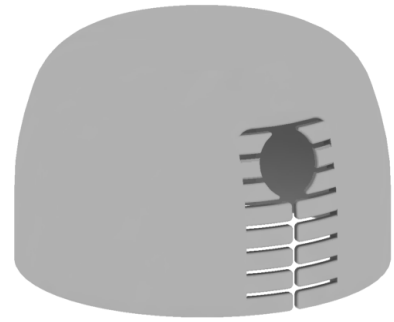

Part Number 275120-4001

Arrester Cap: The standard arrester caps shown feature wide slots for single or through connection lead wires. Other caps are available upon request.

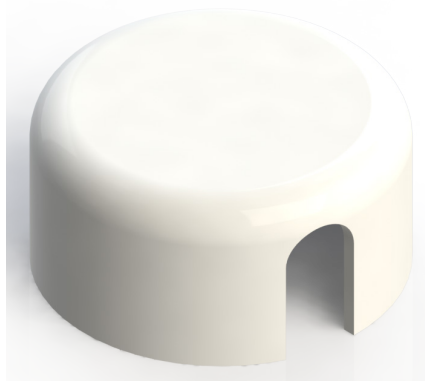

Part Number 273054-4002 for 3/8 inch stud

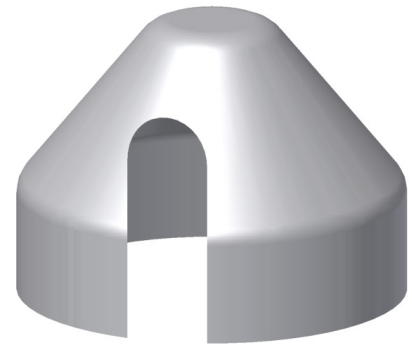

Part Number 271813-4009 for M12 stud

Wildlife Protector Cap: This distribution arrester cap isolates all exposed/energized line end hardware from animal contact. This cap is available for use with the 3/8 inch stud.



PSPPD6CAPKIT1 - 48" LEAD
PSPPD6CAPKIT2 - 18" LEAD

Standard Mounting Brackets

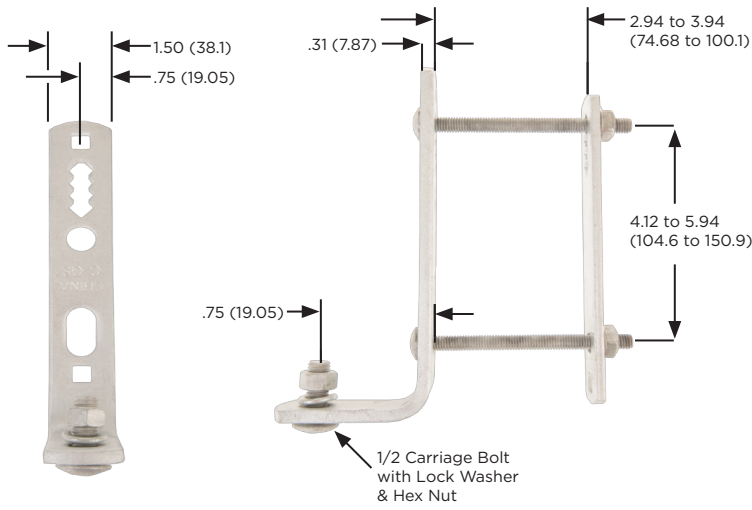

Dimensions: Inches (mm)

Part Number 273456-3001

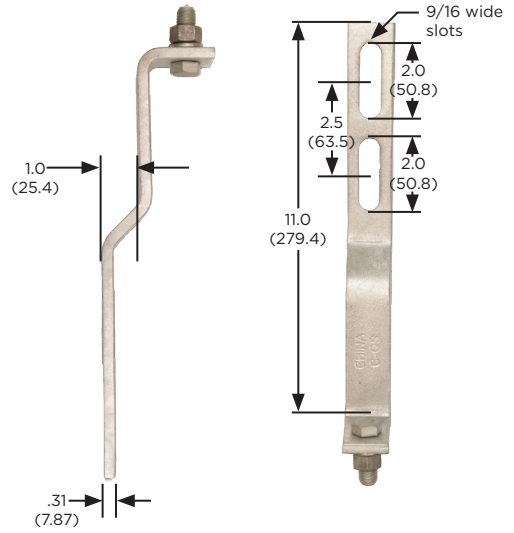

Dimensions: Inches (mm)

Part Number 273066-4004

Note: Non-standard mounting brackets are available.

Transformer Bracket Cover

The transformer bracket cover insulates the mounting bolt and part of the transformer mounting bracket. The transformer bracket cover is used with mounting bracket number 273066-4004.

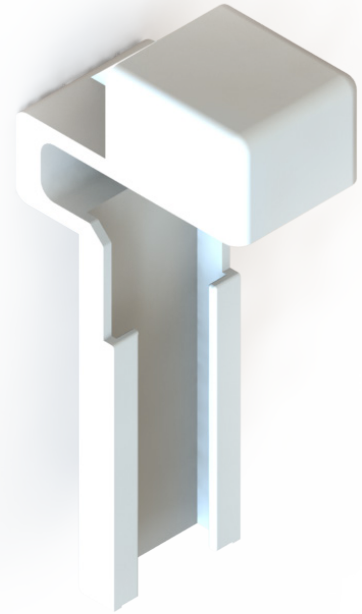

Part Number PSPPD6COV

Arrester FAQs

1. What tightening torque should be used for terminals?

Recommended tightening torques for arrester fasteners are shown below in Table 36.

Table 36: Recommended Tightening Torques

Fastener	Maximum Recommended Tightening Torque
3/8 inch (9.5 mm) line terminal	20 foot-pounds (27 Newton-meters)
3/8 inch (9.5 mm) ground terminal	20 foot-pounds (27 Newton-meters)
1/2 inch (M12) fastener connecting base bracket to cross arm or transformer sidewall bracket	40 foot-pounds (54 Newton-meters)

2. What does MCOV or COV (U_c) rating of a surge arrester mean?

MCOV stands for the Maximum Continuous Operating Voltage. COV or U_c stands for Continuous Operating Voltage. They represent the power frequency voltage that may be continuously applied to a surge arrester.

The MCOV / COV selected for a given system voltage is a function of the maximum line-to-line voltage as well as the system grounding parameters. Hubbell Power Systems Representatives can assist with the proper MCOV / COV selection for your specific requirement.

3. How does MCOV / COV (U_c) rating differ from Duty Cycle rating?

The Duty Cycle rating of a surge arrester is the power frequency voltage at which the arrester can successfully withstand the duty cycle test per IEEE Standard C62.11-2012. The Duty Cycle rating is a short-term TOV (Temporary Over Voltage) rating.

4. What routine maintenance does Hubbell Power Systems recommend for distribution arresters?

Hubbell Power Systems does not recommend any particular maintenance plan. Hubbell Power Systems surge arresters are designed to provide years of excellent service.

5. What field testing does Hubbell Power Systems recommend for distribution arresters?

Hubbell arresters do not require field testing. Properly designed, assembled, selected and applied arresters from reputable manufacturers should be essentially immune to degradation by any cause. If desired, the most commonly performed field test of arrester health is infrared analysis. It is used to determine if the arrester shows a long term trend of increasing heat buildup, which may indicate replacement is needed.

6. What is the standard lead wire length type?

Hubbell arresters use a standard #4 lead wire as the connection from the arrester to the ground. The diameter of the lead connected to the arrester has insignificant effect on the protection offered by the arrester. The lead diameter does not affect the total discharge voltage or arrester clamping ability. IEC standard design testing is completed with lead wires of 5 mm in diameter, which is slightly smaller than a #4 lead wire.

7. What size wires can be attached using the provided terminal?

Hubbell arrester terminals are clamp type and suitable for industry standard wire sizes from No. 6 AWG solid to No. 2 AWG stranded, which are metric sizes 16mm² to 35 mm².

8. Are distribution arresters serialized?

No, distribution arresters are not required to be serialized per IEEE or IEC standard.

9. Are distribution arresters routine tested?

Yes, all distribution arresters are routine tested per the IEEE and IEC standard.



Arrester FAQs

10. Are there any restrictions on how to attach the ground lead connection?

The ground lead disconnect (GLD) needs to be able to completely separate from the arrester. Disconnecting allows the feeder to be re-energized and provides visual indication of the failure location. Disconnecting also allows service to the end user to be restored and voltage to hold.

11. What information is included on the arrester nameplates?

The nameplate on every arrester contains the following information

- Arrester model type
- Catalog number
- Manufacturer
- Country where assembled
- Pressure relief rating
- MCOV/COV
- Rated voltage

Dual IEEE/IEC Nameplate:

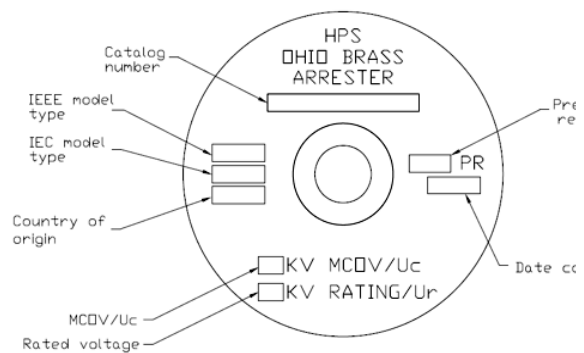

IEEE Nameplate:

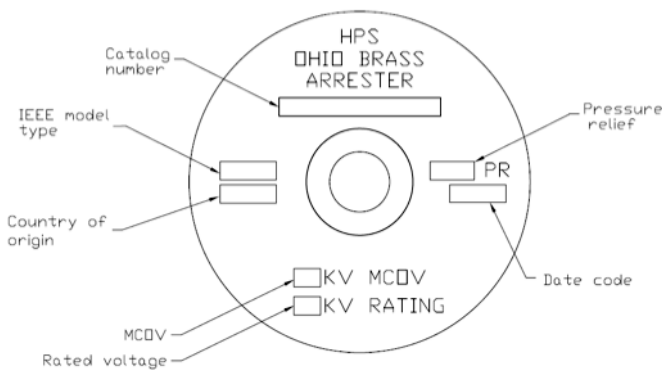

IEC Nameplate:

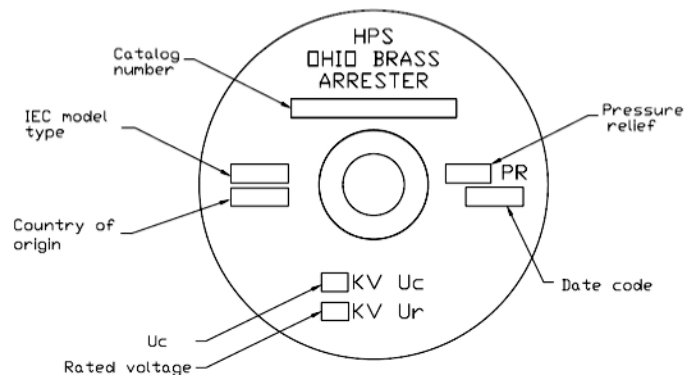

12. What if the arrester does not have the minimum leakage (creep) distance needed for my application?

The following options will only work if more leakage distance is needed. The acronym is HEM. HEM stands for high creep, extra high creep, and mega high creep. This allows the arrester to keep the same U_c (MCOV), but use a larger housing.

- If a 213709-7214 with higher leakage (creep) is needed, the part number would become 213709H-7214
- If additional creep is needed 213709H-7214 is still not high enough, the part number would become 213709E-7214.

13. What if I have a question that is not covered in this section.

Contact your local Hubbell Power Systems sales representative or call our main customer service line at 1.573. 682.5521.

Engineering Terminology

A Glossary of Terms Used in This Catalog

BIL (Basic Impulse Level): The electrical strength of insulation in terms of the peak value of a standard lightning impulse under standard atmospheric conditions.

COV (Continuous Operating Voltage, U_c): The designated root-mean-square (rms) value of power-frequency voltage that may be applied continuously between the terminals of the arrester.

Design Tests: Tests made on each design to establish performance characteristics and to demonstrate compliance with the appropriate standards of the industry. Once made, they need not be repeated unless the design is changed so as to modify performance.

Discharge Voltage (Residual Voltage): The voltage that appears across the terminals of an arrester during passage of discharge current.

Fault Current: The current from the connected power system that flows in a short circuit.

Ground Terminal: The conducting part provided for connecting the arrester to ground.

Leakage (creepage): The distance between the two terminals of an arrester drawn along the outside surface of the housing

Line Terminal: The conducting part of an arrester provided for connecting the arrester to the circuit conductor.

MOV (Metal Oxide Varistor): The disc of zinc oxide semiconductor that limits the surge voltage allowing the arrester to perform its protection function. This is the electrically active component of the surge arrester.

MCOV (Maximum Continuous Operating Voltage): The maximum designated root-mean-square (rms) value of power-frequency voltage that may be applied continuously between the terminals of the arrester.

MDCL (Maximum Design Cantilever Load): The maximum cantilever load the surge arrester is designed to continuously carry.

Partial Discharge (PD): A localized electric discharge resulting from ionization in an insulation system when the voltage stress exceeds critical value. The discharge partially bridges the insulation between electrodes.

Peak Value: The maximum value that a wave, surge or impulse attains.

Phase-Ground clearance: The phase to ground spacing required between metal parts at 1800m in order to prevent flashover.

Phase-Phase clearance: The phase to phase spacing required between metal parts at 1800m in order to prevent flash over.

Reference Current (I_{ref}): The peak value of the resistive component of a power-frequency current high enough to make the effects of stray capacitance of the arrester negligible.

Reference Voltage (V_{ref}): The lowest peak value independent of polarity of power-frequency voltage, divided by the square root of 2, required to produce a resistive component of current equal to the reference current of the arrester.

Routine Tests: Tests made by the manufacturer on every device to verify that the product meets the design specifications.

SLL (Specified Long-Term Load): Force perpendicular to the longitudinal axis of an arrester, allowed to be continuously applied during service without causing any mechanical damage to the arrester.

SSL (Specified Short-Term Load): Greatest force perpendicular to the longitudinal axis of an arrester, allowed to be applied during service for short periods and for relatively rare events (for example, short-circuit current loads and extreme wind gusts) without causing any mechanical damage to the arrester.

Steep front: A nominal discharge current impulse with a front time of 0.5 micro seconds.

Strike distance: The distance in air of a line between two conductors on the arrester.

Switching Surge: The surge current when a system changes configuration.

TOV (Temporary Over Voltage): A power frequency voltage in excess of normal line-to-ground voltage. A TOV is typically system-generated. The magnitude and duration are a function of the power system parameters.

Watts Loss: Loss of power through arrester when operating at MCOV

Wet Withstand: Maximum residual voltage in wet conditions for which the arrester is rated.

NOTE: Because Hubbell has a policy of continuous product improvement, we reserve the right to change design and specifications without notice.
©Copyright 2017 Hubbell Incorporated

OHIO BRASS

Never Compromise™
www.hubbellpowersystems.com



Printed in USA